

Passivity-based controller for chemical processes

Oscar Camacho¹, Rubén Rojas¹, Alpha Pernía-Espinoza¹
and Mercedes Pérez de la Parte²

¹Postgrado en Automatización e Instrumentación,
Grupo en Nuevas Estrategias de Control Avanzadas (GINECA), Facultad de Ingeniería,
Universidad de Los Andes. Mérida 5101, Venezuela. Tel.: 58-274-2402891.
Fax: 58-274-2402890. E-mail: ocamacho@ing.ula.ve.

²Departamento de Sistemas y Automática, Escuela Superior de Ingenieros,
Universidad de Sevilla. Camino de los Descubrimientos, s/n. Sevilla 41092, España

Abstract

This paper presents the development of a *Passivity-Based Controller* (PBCr) from a First-Order-Plus-Dead-Time model of the process. This approach results in a fixed structure controller that depends on the characteristic parameters of the model. This allows a unique controller of adjustable parameters that can be used in several processes. Computer simulations on a nonlinear chemical process judge the controller performance. The simulation results showed effectiveness and good performance for the studied case.

Key words: Passivity-based control, nonlinear chemical processes, dead-time.

Control basado en pasividad para procesos químicos

Resumen

En este trabajo se presenta el desarrollo de un controlador basado en Pasividad derivado a partir del modelo de Primer Orden Más Tiempo Muerto (POMTM) del proceso. El resultado de esta propuesta es un controlador de estructura fija que depende de los parámetros característicos del modelo. Por tanto se cuenta con un controlador único de parámetros ajustables que puede ser empleado en diferentes procesos. Para la evaluación del controlador se realizaron simulaciones sobre un proceso químico no lineal. Los resultados muestran la efectividad y buen desempeño del controlador en el caso estudiado.

Palabras clave: Control basado en pasividad, procesos químicos no-lineales, tiempo muerto.

1. Introduction

The theory about passivity for nonlinear process control was firstly studied by Willems [1] who built a general theory of dissipative systems. Popov [2] introduced the concept of passivity as a fundamental property of feedback systems.

A system is said to be passive if the increase in the stored energy, in a given time interval, is lower or equal to the energy supplied to the sys-

tem, in the same interval. This characteristic made a passive system stable in the sense of Liapunov. The passivity strategy uses the property of stability of the passive systems to derive a feedback control law. Also another concept, the *damping injection*, is used to ensure the asymptotically convergence of the system to the desired equilibrium state.

The passivity method has found many applications in the electrical and mechanical fields

with good results [3, 4]. Recently, these concepts also have been applied to chemical and biological processes [5, 6].

To develop a Passivity-Based Controller, PBCr, knowledge of the process model relating the controlled variable, $X_C(t)$, to the manipulated variable, $U(t)$, is necessary. Mathematical models of the system solve most of the control problems. In the industry, there are many complex processes whose accurate mathematical models are not available or difficult to obtain. As far as chemical processes are concerned, the development of a complete model is difficult due mainly to the complexity of the process itself, and to the lack of knowledge of some process parameters. Second, most process models relating the controlled and the manipulated variables are of higher-order. Generally, the PBC procedure produces a complex controller, which could contain four or more parameters resulting in a difficult tuning job. Therefore, the use of the traditional procedures of PBC would present disadvantages in their application to chemical processes.

It is a common procedure to use approximating system models for controller design. If the frequency responses of the approximating model and the original system coincide within drawing accuracy, so do the closed-loop responses of both systems [7]. An efficient modeling method alternative for process control is the use of empirical models, which use low order linear models with deadtime. Many times, First-Order-Plus Deadtime (FOPDT) models are adequate for chemical process control analysis and design [8]. Some times these reduced models present uncertainties arising from imperfect modeling of the process nonlinearities that contribute to performance degradation of the controller [9].

The aim of this paper is to design a PBCr based on an FOPDT model of the actual process. The overall idea is to develop a general PBCr, which can be used for self-regulating chemical processes. It is expected that due to the robustness shown by PBCr, the proposed controller would deal with model uncertainties and perturbations.

This article is organized as follows. Section 2 presents some basic concepts of the PBC theory. Section 3 shows the procedure to design a PBCr using the FOPDT model. Tuning equations

for the controller are also given in this section. In Section 4 the simulation of the PBCr for a nonlinear chemical reactor is presented. Section 5 concludes the paper.

2. Passivity Background Definitions

Considering a SISO system represented by

$$\begin{aligned} \dot{z} &= f(z) + g(z)u \\ y &= h(z) \end{aligned} \quad (1)$$

where $z \in Z \subset \mathbf{R}^n$ is the state vector, $u \in U \subset \mathbf{R}$ is the control input and $y \in Y \subset \mathbf{R}$ is the output function of the system. The vector fields $f(z)$ and $g(z)$ are assumed to be smooth vector fields on Z .

Assuming that an associated energy storage function $S: Z \mapsto \mathfrak{R}^+$ exists. The supply rate is defined as a function $\omega, U \times Y \mapsto \mathfrak{R}$.

Definition 1

System (1) is said to be passive with respect to the supply rate $\omega = u y$ if the following relation holds

$$\dot{S}(z(t)) \leq u(t) \cdot y(t) \quad (2)$$

This relation is called the passivity inequality [6].

Definition 2

System (2) is said to become passive with respect to the storage function S if there exists a regular affine feedback law of the form

$$u = \alpha(z) + \beta(z)w \quad ; \quad \alpha(z) \in \mathbf{R}; \beta(z) \in \mathfrak{R} \quad (3)$$

where $\beta(z)$ is a non-zero scalar function in Z , and such that the closed-loop system (1)-(3) becomes passive with respect to a new scalar control input w [6].

3. Passivity-Based Control from an FOPDT Model of the Process

This section presents the development of a PBCr from an FOPDT model of the process.

3.1 Study of the process model: FOPDT

The First Order plus Dead-Time (FOPDT) model of the process is expressed by

$$\frac{X_1(s)}{U(s)} = \frac{Ke^{-t_0s}}{\tau s + 1} \quad (4)$$

where $X_1(s)$ is the Laplace transform of the controlled variable, the transmitter output, and $U(s)$ is the Laplace transform of the manipulated variable, the controller output. Both $X_1(s)$ and $U(s)$ are deviation variables. The characteristic parameters of the process are: dead time, t_0 , static gain, K , and time constant, τ .

The dead time can be approximated in two different ways. A first-order Taylor series approximation to the deadtime term produces

$$e^{-t_0s} \cong \frac{1}{t_0s + 1} \quad (5)$$

The above approximation can also be written as a first-order Padé Approximation

$$e^{-t_0s} \cong \frac{1 - 0.5t_0s}{1 + 0.5t_0s} \quad (6)$$

Figure 1 shows a comparison among the deadtime term and the first-order Taylor series and Padé Approximations. The figure shows that the Padé Approximation works very well between

0 and 1 but beyond the approximation brakes down. On other hand, the Taylor series approximation improves as t_0 increases. The first-order Taylor approximation or the Padé approximation can be considered as good approximations for the deadtime term for chemical processes as has been shown previously [10].

If the first-order Taylor series approximation is substituted into equation (4), it is obtained

$$\frac{X_1(s)}{U(s)} = \frac{K}{(\tau s + 1)(t_0s + 1)} \quad (7)$$

and, if it is replaced the Padé approximation into equation (4), the following result is obtained

$$\frac{X_1(s)}{U(s)} = \frac{K(1 - 0.5t_0s)}{(\tau s + 1)(1 + 0.5t_0s)} \quad (8)$$

Equation (7) represents a minimum phase system and equation (8) represents a non-minimum phase system. Up to now, the passivation procedure has been applied to minimum phase systems [4, 6]. Since, the Padé approximation produces a non-minimum phase system; the actual procedure can not be directly used to synthesize the passive controller for this kind of systems. Therefore, the Taylor series approximation is chosen to design the controller.

On the other side, it was shown in [11] that the first-order Taylor series approximation can

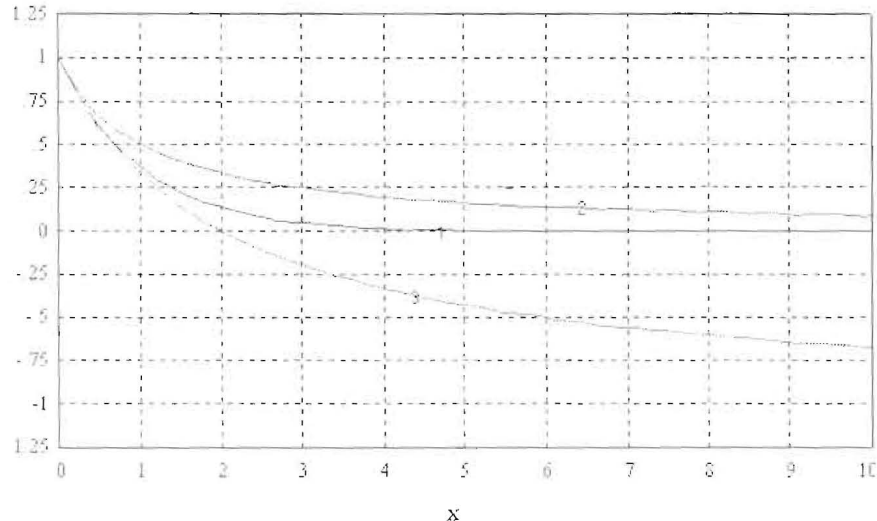

Figure 1. Comparison among e^{-x} (1), Taylor (2) and Padé (3) approximations.

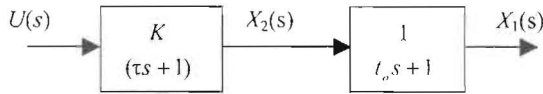

Figure 2. Block diagram realization of the system model given by equation (7).

be used to handle the dead time term without any problem for chemical processes.

Using an auxiliary variable $X_2(s)$ the system model given by equation (7) can be schematized as shows Figure 2.

Now, the model of the process can be rewritten in state variables as follows:

$$\begin{cases} \dot{x}_1 = (x_2 - x_1)D - A \\ \dot{x}_2 = -\frac{x_2}{\tau} + B + CU \\ y = x_1 \end{cases} \quad (9)$$

where

$$\begin{aligned} A &= \frac{1}{t_0}(\bar{x}_2 - \bar{x}_1) ; & B &= \frac{\bar{x}_2}{\tau} \\ C &= \frac{K}{\tau} ; & D &= \frac{1}{t_0} \end{aligned} \quad (10)$$

We assume that the value of the variables x_1 and x_2 are always positive for all times ($x(t) \geq 0$).

Following the passivation procedure proposed by Sira and Angulo [6]; for chemical processes, the following storage function can be used:

$$S(x) = \frac{1}{2} x^T x \quad (11)$$

where x is the state vector. For the system given by equation (9), the storage function derivative is obtained

$$\begin{aligned} \dot{S}(x) &= x_1 \dot{x}_1 + x_2 \dot{x}_2 \\ \dot{S}(x) &= x_1 x_2 D - x_1^2 D - A x_1 + B x_2 - \frac{x_2^2}{\tau} + C x_2 U \end{aligned} \quad (12)$$

To ensure the passivity inequality fulfillment, equation (2), it is essential to define a state-dependent input coordinate transformation as follows:

$$U = \frac{1}{C} \left(W \frac{x_1}{x_2} - x_1 D - B \right) \quad (13)$$

Substituting this expression into the system model (9) we obtain

$$\begin{cases} \dot{x}_1 = (x_2 - x_1)D - A \\ \dot{x}_2 = -\frac{x_2}{\tau} - x_1 D + W \frac{x_1}{x_2} \\ y = x_1 \end{cases} \quad (14)$$

This system has a passivity inequality of the form $\dot{S}(x) \leq x_1 W$. So, transformation (13) results in a passive system operator relating the new input W and the output variable x_1 .

Now, the overall passive system can be rewritten in the canonical form [12]

$$\dot{x} = -R(x)x - J(x)x + M(x)W \quad (15)$$

in this case

$$\begin{aligned} -R(x) &= \begin{pmatrix} -R_{11} & 0 \\ 0 & -1/\tau \end{pmatrix} ; & \text{with } R_{11} &= \left(D + \frac{A}{x_1} \right) \\ -J(x) &= \begin{pmatrix} 0 & -D \\ D & 0 \end{pmatrix} ; & M(x) &= \begin{pmatrix} 0 \\ x_1/x_2 \end{pmatrix} \end{aligned} \quad (16)$$

where $R(x)$ is a positive semi-definite matrix, and $J(x)$ is an anti-symmetric matrix.

3.2. Passivity Based feedback controller synthesis

The derivation of the control law was done based on a modified storage function $S_d(x)$ and *damping injection* through feedback [6]. The modified storage function, $S_d(x)$, is related to the Lyapunov storage function. Its properties were used to derivate an auxiliary system from which the control law was obtained. The *damping injection* was used to ensure the asymptotically convergence of the system to the desired equilibrium state.

Then a passivity-based controller was proposed for a system given in the equation (15) form, considering the following modified storage function

$$S_d(x, x_d) = \frac{1}{2} (x - x_d)^T (x - x_d) \quad (17)$$

where x_d is an auxiliary state vector to be defined later. Along the solution of the system (15), the function $S_d(x, x_d)$ have the following time derivative

$$\dot{S}_d(x, x_d) = (x - x_d)^T [-Rx - Jx + MW - \dot{x}_d] \quad (18)$$

Completing terms in the right side and adding a *damping injection* term of the form $-R_{di}(x - x_d)$, so that $Rm = R + R_{di}$ be a positive defined matrix, asymptotic stability is ensure. For simplicity R_{di} is taken to be a constant matrix,

$$R_{di} = \begin{pmatrix} R_1 & 0 \\ 0 & R_2 \end{pmatrix}; \text{ with } R_1, R_2 > 0 \quad (19)$$

So the modified storage function derivative can be written as follows:

$$\dot{S}_d(x, x_d) = (x - x_d)^T [(R + R_{di})(x - x_d) - J(x - x_d) - \dot{x}_d - Rx_d - Jx_d + R_{di}(x - x_d) + MW] \quad (20)$$

Now, let the auxiliary state vector $x_d(t)$ satisfy the following state equation representation

$$\dot{x}_d = -Rx_d - Jx_d + R_{di}(x - x_d) + MW \quad (21)$$

Note that is a time varying linear system for the auxiliary state x_d . Then, R_1 and R_2 are chosen so that the time derivative of $S_d(x, x_d)$ satisfies

$$\dot{S}_d(x, x_d) = -(x - x_d)^T R_m (x - x_d) \leq 0 \quad (22)$$

It follows that the vector $x(t)$ exponentially asymptotically converges towards the auxiliary vector trajectory $x_d(t)$.

Substituting $R(x)$, $J(x)$ and $M(x)$ as defined, equation (16), in equation (21) the following state equation is obtained

$$\begin{cases} \dot{x}_{1d} = -\left(D + \frac{A}{x_1}\right)x_{1d} + Dx_{2d} + R_1(x_1 - x_{1d}) \\ \dot{x}_{2d} = -\frac{x_{2d}}{\tau} - Dx_{1d} + R_2(x_2 - x_{2d}) + \frac{x_1}{x_2}W \end{cases} \quad (23)$$

This system is stable in the Lyapunov sense with storage function given by equation (17). Because of linear characteristics, it is easy to obtain

the control law via feedback. Then, x_{2d} is set to a desired constant equilibrium value \bar{x}_2 . This is related to the component value in the equilibrium state of the original state vector (z). It has to be in the interval $0 < \bar{x}_2 < \bar{x}_1$, to be consistent with the coordinate transformation (10), where the constant value A was taken as positive.

Letting, thus, $x_{2d} = \bar{x}_2$, and after some mathematical manipulations the dynamic feedback controller is obtained

$$W = \frac{x_2}{x_1} \left(\frac{\bar{x}_2}{\tau} + Dx_{1d} - R_2(x_2 - \bar{x}_2) \right) \quad (24)$$

Finally, replacing W in equation (13), the expression of the general passivity controller based on the FOPDT model is obtained

$$\begin{cases} u = \frac{1}{C} [-D(x_1 - x_{1d}) - R_2(x_2 - \bar{x}_2)] + \bar{u} \\ \dot{x}_{1d} = -\left(D + \frac{A}{x_1}\right)x_{1d} + D\bar{x}_2 + R_1(x_1 - x_{1d}) \end{cases} \quad (25)$$

Thus, a Passivity-Based controller of fixed structure has been designed with adjusting parameters:

C , D , R_1 and R_2

C and D depending entirely of the characteristic parameters of the process: K , τ and t_0 . R_1 and R_2 are tuning parameters chosen to satisfy (18).

On the other hand, C and D determine the aggressivity of the controller, while R_1 and R_2 determine the damping factor and the setting time of the process.

In some cases, the obtained PBCr, presents steady state error different of zero. It could be caused by the imperfection of the modeling. The FOPDT model is a reduced order model that presents uncertainties arising from imperfect knowledge of the system, and the process non-linear effects that contribute to performance degradation of the controller. In order to improve the controller closed loop performance an integral term was added. Then equation (25) was modified, and the final controller based on the FOPDT model is

$$\begin{cases} u = \frac{1}{C} [-D(x_1 - x_{1d}) - R_3 \int (x_1 - x_{1d}) dt - R_2(x_2 - \bar{x}_2)] + \bar{u} \\ \dot{x}_{1d} = -\left(D + \frac{A}{x_1}\right)x_{1d} + D\bar{x}_2 + R_1(x_1 - x_{1d}) \end{cases} \quad (26)$$

Figure 3 shows the modified structure of the controller. The x_{1d} dynamic is represented by the second line in equation (26).

4. Evaluation of the PBCr designed

This section presents a simulation test of the proposed controller, previously designed, in the regulation of an exothermic continuously stirred tank reactor (CSTR) system.

The process model assumes that [8]: the reactor and the jacket are perfectly mixed; all the volumes and physical properties remain constant and the heat losses may be neglected.

$$\begin{aligned} \dot{z}_1 &= \frac{F}{V}(C_{Ai} - z_1) - k_0 \exp\left[-\frac{E}{R(z_2 + 273.16)}\right] z_1^2 \\ \dot{z}_2 &= \frac{F}{V}(T_i - z_2) - \frac{\Delta H_R}{\rho C_p} k_0 \exp\left[-\frac{E}{R(z_2 + 273.16)}\right] z_1^2 - \\ &\quad \frac{U_T A_T}{V \rho C_p} (z_2 - z_3) \\ \dot{z}_3 &= \frac{U_T A_T}{V_c \rho_c C_{pc}} (z_2 - z_3) - \frac{F_{Cmax} \alpha^{-u}}{V_c} (z_2 - T_c) \\ y &= z_2 \end{aligned} \quad (27)$$

where z_1 is the concentration of the reactant in the reactor (kgmol/m^3), z_2 is the temperature in the reactor ($^{\circ}\text{C}$), z_3 is the jacket temperature ($^{\circ}\text{C}$), u is the controller output signal limited to the interval $[0, 1]$ and represents the position function of an equal percentage valve. F is the feed rate (m^3/s), V is the reactor volume (m^3), C_{Ai} is the concentration of the reactant in the feed (kgmol/m^3), k is the reaction rate coefficient ($\text{m}^3 \text{kgmol}^{-1} \text{s}^{-1}$), T_i is the temperature of the feed ($^{\circ}\text{C}$), ΔH_R is the heat of the reaction, assumed to be constant (J kgmol^{-1}), ρ is the density of the reactor contents (kgmol/m^3), C_p is the heat capacity of the reactants ($\text{J kgmol}^{-1} \text{s}^{-1}$), U_T is the overall heat transfer coefficient ($\text{J s}^{-1} \text{m}^{-2} \text{^{\circ}C}^{-1}$), A_T is the heat transfer area (m^2), V_c is the jacket volume

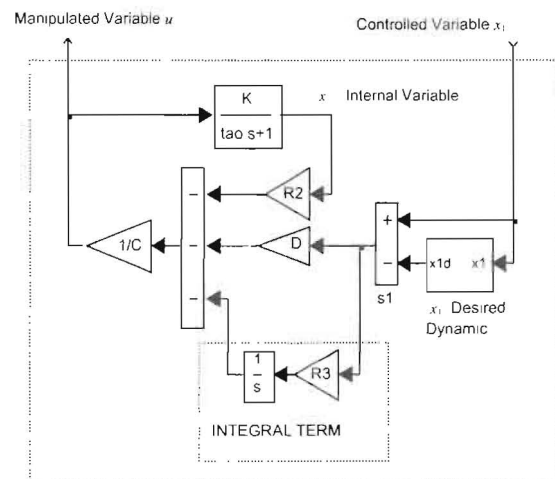

Figure 3. PBCr scheme.

(m^3), ρ_c is the density of the coolant in the jacket (kg/m^3), C_{pC} is the specific heat of the coolant ($\text{J kg}^{-1} \text{^{\circ}C}^{-1}$), F_C is the coolant rate (m^3/s), T_{ci} is the coolant inlet temperature ($^{\circ}\text{C}$), k_0 is the Arrhenius frequency parameter ($\text{m}^3 \text{s}^{-1} \text{kgmol}^{-1}$), E is the activation energy of the reaction (J/kgmol), R is the ideal gas law constant ($\text{J kgmol}^{-1} \text{K}^{-1}$), F_{Cmax} is the maximum flow through the control valve (m^3/s) and α is the rangeability parameter.

Simulations were performed using the following values [8]:

$$V = 7.08 \text{ m}^3; \rho = 19.2 \text{ kgmol}/\text{m}^3;$$

$$C_p = 1.8115 \times 10^5 \text{ J kgmol}^{-1} \text{ s}^{-1};$$

$$V_c = 1.82 \text{ m}^3; A_T = 5.40 \text{ m}^2; \rho_c = 1000 \text{ kg}/\text{m}^3;$$

$$k_0 = 0.0744 \text{ m}^3 \text{ s}^{-1} \text{ kgmol}^{-1};$$

$$C_{pC} = 4184 \text{ J kg}^{-1} \text{^{\circ}C}^{-1};$$

$$E = 1.182 \times 10^7 \text{ J}/\text{kgmol}; F_{Cmax} = 0.020 \text{ m}^3/\text{s};$$

$$F = 7.5 \times 10^{-3} \text{ m}^3/\text{s}; \alpha = 50;$$

$$\Delta H_R = -9.86 \times 10^7 \text{ J kgmol}^{-1};$$

$$U_T = 3550 \text{ J s}^{-1} \text{ m}^{-2} \text{^{\circ}C}^{-1}; C_{Ai} = 2.88 \text{ kgmol}/\text{m}^3;$$

$$T_{ci} = 27^{\circ}\text{C}; T_i = 66^{\circ}\text{C}$$

and the equilibrium states of the process for a non-zero constant \bar{u} as:

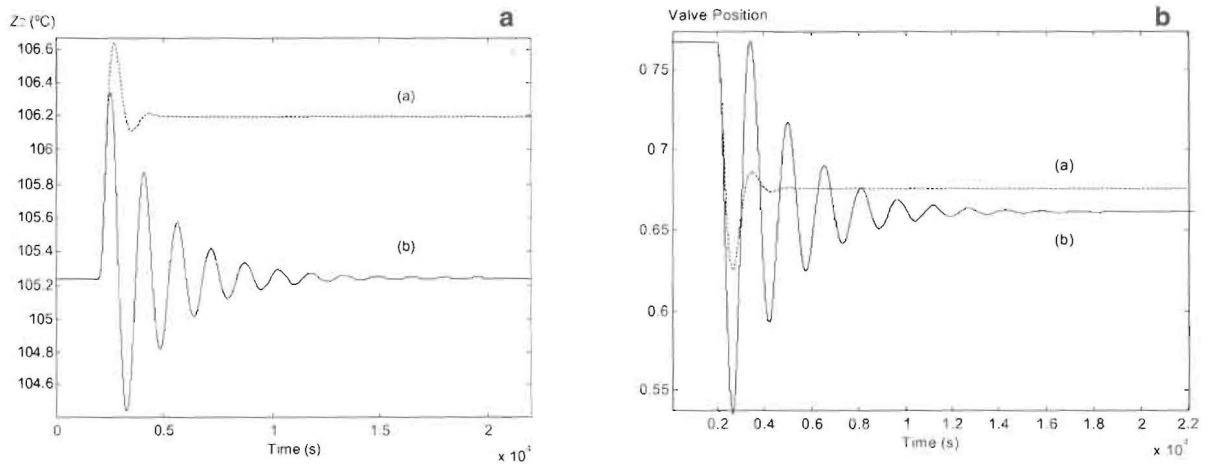

Figure 4. Closed-loop system response and control signal when C_{Ai} changes by 10%. (a) without integral term, (b) with integral term.

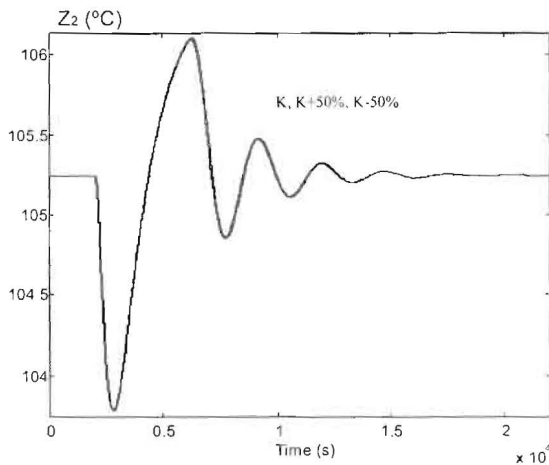

Figure 5. System response with $\pm 50\%$ modeling error in static gain K , and disturbance of $-10\% C_{Air}$.

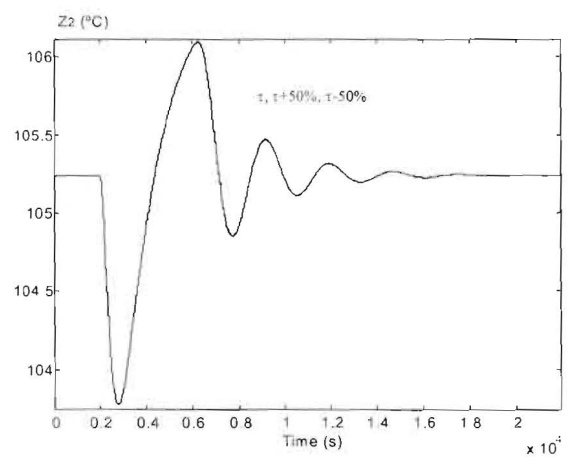

Figure 6. System response with $\pm 50\%$ modeling error in time constant τ , and disturbance of $-10\% C_{Air}$.

$$\bar{z}_1 = 1.054 \text{ kgmol/m}^3; \bar{z}_2 = 105.242^\circ\text{C};$$

$$\bar{z}_3 = 88.234^\circ\text{C}; \bar{u} = 0.7668$$

The characteristic parameters obtained from the reaction curve of the process were:

$$K = 0.1996 \text{ \%TO/\%CO};$$

$$\tau = 1498.5 \text{ s}; t_0 = 308.5 \text{ s}$$

so the PBCr parameters were set to:

$$R_1 = 10 \mu\text{s}^{-1}; R_2 = 10 \mu\text{s}^{-1}; R_3 = 10 \mu\text{s}^{-1};$$

$$\bar{x}_2 = 0.6 \text{ TO s}^{-1}; D = 3.2 \text{ ms}^{-1};$$

$$C = 133.2 \text{ (TO/CO) } \mu\text{s}^{-1}$$

Figure 4 shows the closed-loop response of the CSTR when the inlet concentration C_{Ai} changes by $+10\%$. This is one of the most influential variables of the process. In both cases, the response is very oscillatory. Oscillations can be reduced decreasing R_1 .

Figures 5, 6 and 7 illustrate the controller performance when the system presents modeling errors when the system presents modeling errors in steady-state gain (K), time constant (τ), and dead time t_0 . This figures depicted that the PBCr is robust against modeling errors, with zero steady state error in all cases. The worst case is for the deadtime case, but the PBCr can deal with it.

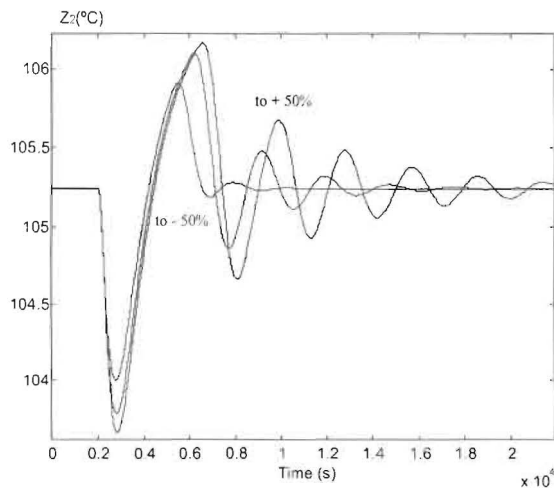

Figure 7. System response with $\pm 50\%$ modeling error in Dead time t_0 , and disturbance of -10% C_{Air} .

Figure 8 shows the effect of decreasing R_1 to $R_1/3$. As can be observed, this parameter has a similar effect to the integral gain in a PID controller. R_2 also determines the damping factor, but it is less sensitive than R_1 .

Note that the proposed controller, equation (21), is independent of the process model and present a fixed structure.

5. Conclusions

This paper showed the synthesis of a PBCr from a FOPDT model of the process. The derivation of the controller is based on the modification of the storage energy function and the enhancing of the dissipation structure of the model by suitable *damping injection*. An integral filter was added in order to improve the controller performance.

The proposed controller equation is simple, with fixed structure and tuning parameters as a function of the characteristic parameters of the process. Also, the physical meaning of the tuning parameters is given.

As can be seen from the simulations, the PBCr presents effectiveness and robustness with respect to disturbances and modeling errors. The combination PBCr plus filter yield asymptotically stable closed-loop behavior, with zero steady state error.

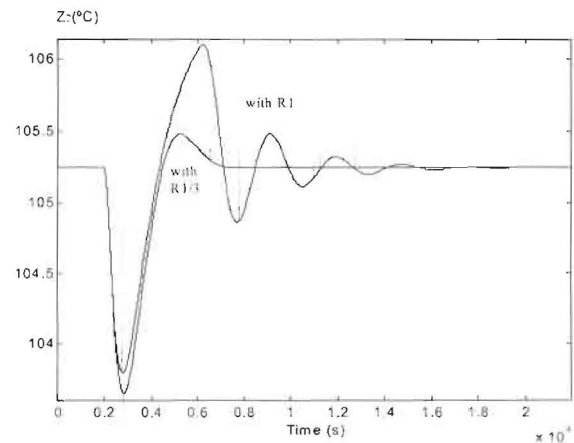

Figure 8. Responses comparison when R_1 is adjusted to $R_1/3$, in the presence of a disturbance of -10% in C_{Air} .

The PBCr designed in this paper, can be used for different chemical processes and be implemented easily in a DCS.

References

1. Willems J.: "Dissipative Dynamic Systems, Part I y II", Archives of Rational Mechanics and Analysis, Vol. 45, (1972), 321-393.
2. Popov V.: "Hyperstability of Control Systems", Springer-Verlag, New York, 1973.
3. Ortega R. and M. Spong: "Adaptive Motion Control of Rigid Robots: A tutorial", Automatica, Vol. 25, (1989), 877-888.
4. Sira H., R. Pérez, R. Ortega, and M. García "Passivity-based Controllers for the Stabilization of DC-to-DC Power Converters", Automatica, Vol. 33, (1997), 499-513.
5. Alonso A. and E. Ydstie: "Process Systems, Passivity and the Second law of Thermodynamics", Computers in Chemical Engineering, Vol.20, (1996), S1119-S1124 (supplement).
6. Sira H. and M. Angulo: "Passivity-based Control of Nonlinear Chemical Processes", International Journal of Control, Vol. 68, No.5, (1997), 971-996.
7. Stahl H., and P. Hippe: "Design of Pole Placing Controllers For Stable and Unstable Systems with Pure time delay", International

- Journal of Control, Vol. 45, No.6, (1987), 2173-2182.
8. Smith C., and A. Corripio: "Principles and Practice of Automatic Control", John Wiley and Sons, Inc., New York, 1985.
 9. Slotine, J and W. Li: "Applied Nonlinear Control", Prentice Hall, New Jersey, 1991.
 10. Camacho O., and C. Smith: "Sliding Mode Control an Approach to Regulate Nonlinear Chemical Processes", ISA Transactions. Vol. 39 (2) (2000), 205—218
 11. Camacho O., R. Rojas and W. García: "Variable Structure Control Applied to Chemical Processes with Inverse Response", ISA Transactions, Vol. 38, (1999), 55-72.
 12. Sira H.: "A General Canonical Form for Feedback Passivity of Nonlinear Systems", International Journal of Control. Vol. 71, No.5, (1998), 891-905.

Recibido el 15 de Junio de 2000

En forma revisada el 20 de Febrero de 2002